

### RA-25 Receiver Adapters, Bent with Multiple Connection (PIG)

Cat. No.	Socket	Cone
1190	10/19	10/19
1191	14/23	14/23
1192	19/26	14/23
1193	19/26	19/26
1194	24/29	14/23
1195	24/29	19/26
1195/a	24/29	24/29
1196	29/32	14/23

### RA-26 Receiver Adapters, Multi-Limb, vacuum with

Cat. No.	Socket	Cone
1197	19/26	14/23
1198	24/29	19/23
1199	24/29	24/29

### RA-27 Receiver Adapters, Sloping Delivery

Cat. No.	Socket	Cone
1200	19/26	19/26
1201	24/29	24/29

### RA-28 Receiver Adapters, Vertical Delivery

Cat. No.	Socket	Cone
1202	19/26	19/26
1203	24/29	24/29

### IRA-29 Intermediate Receiver Adapters (PERKIN)

Cat. No.	Socket	Cone	Cap ml.
1204	14/23	14/23	10
1205	19/26	19/26	32
1206	19/26	24/29	32
1207	24/29	24/29	32

### RBS-30 Recovery Bend, Sloping

Cat. No.	Flask Cone	Cond. cone
1208	14/23	14/23
1209	19/26	19/26
1210	24/29	14/23
1211	24/29	19/26
1212	24/29	24/29
1213	29/32	19/26
1214	29/32	29/32
1215	34/35	19/26
1216	34/35	24/29
1217	34/35	34/35

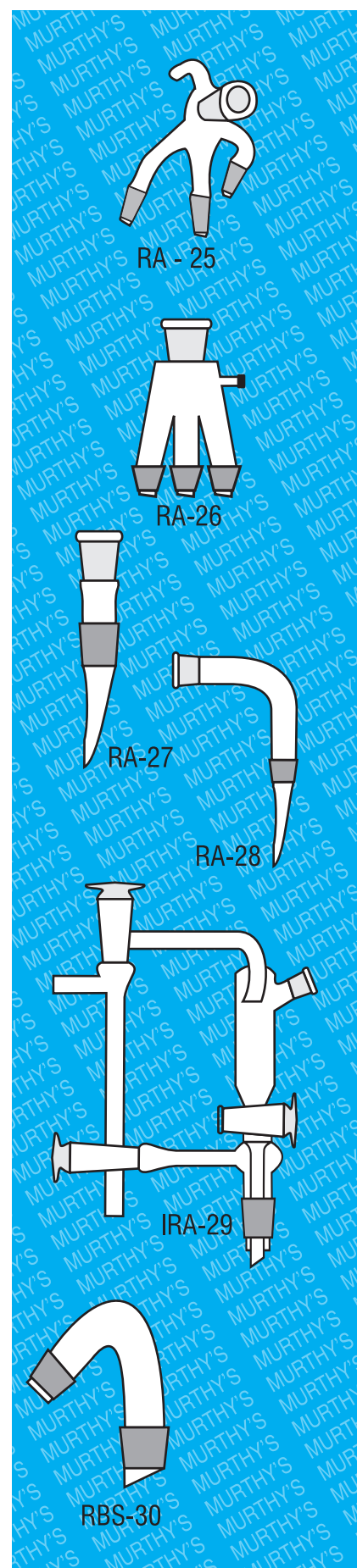

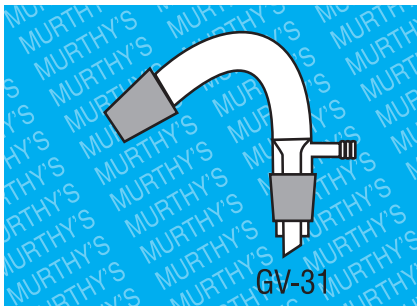

### GV-31 Goose Neck with vac connection

Cat. No.	Flask Cone	Cond. cone
1218	14/23	14/23
1219	14/23	19/26
1220	19/26	19/26
1221	19/26	24/29
1222	24/29	24/29

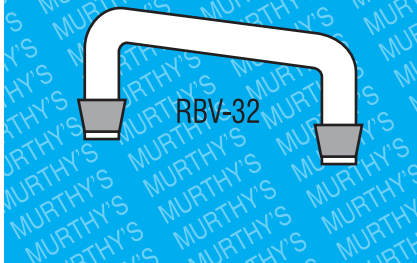

### RBV-32 Recovery Bend Vertical

Cat. No.	Flask Cone	Cond. cone
1223	14/23	14/23
1224	19/26	19/26
1225	24/29	19/26
1226	24/29	24/29
1227	29/32	29/32
1228	34/35	34/35

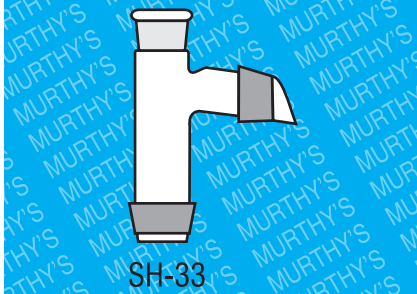

### SH-33 Plain Stillheads, Sloping Distillation Head

Cat. No.	Flask cone	Cond. cone	Socket
1229	10/13	10/13	10/19
1230	14/23	14/23	14/23
1231	19/26	19/26	14/23
1232	19/26	19/26	19/26
1233	24/29	19/26	14/23
1234	24/29	24/29	14/23
1234/a	24/29	24/29	24/29
1235	29/32	19/26	14/23
1236	29/32	24/29	14/23
1237	29/32	29/32	14/23
1238	34/35	19/26	14/23
1239	34/35	24/29	14/23
1240	34/35	34/35	14/23
1241	34/35	34/35	24/29
1242	40/40	24/29	24/29

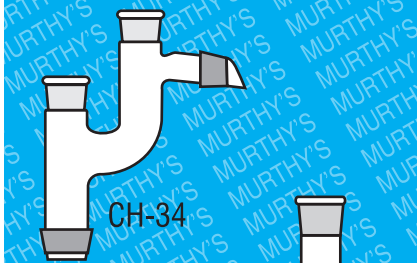

### CH-34 Claisen heads, Sloping

Cat. No.	Flask cone	Cond. cone	Socket
1243	14/23	14/23	14/23
1244	19/26	19/26	14/23
1245	24/29	19/26	14/23
1246	24/29	24/29	14/23
1247	29/32	29/32	14/23
1248	34/35	19/26	14/23

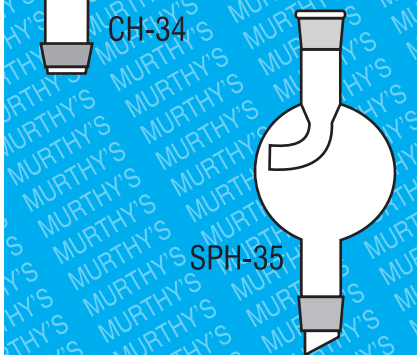

### SPH-35 Splash Head Adapters

Cat. No.	Socket	Cond. Cone
1249	14/23	14/23
1250	19/26	24/29
1251	24/29	24/29

### SPH- 36 Splash Heads, Sloping

Cat. No.	Flask Cone	Cond. Cone
1252	14/23	14/23
1253	19/26	19/26
1254	24/29	19/26
1255	24/29	24/29
1256	29/32	19/26
1257	29/32	29/32
1258	34/35	19/26
1259	34/35	24/29
1260	34/35	34/35

### SPH-37 Splash Heads, Vertical

Cat. No.	Flask Cone	Cond. cone
1261	19/26	19/26
1262	24/29	19/26
1263	24/29	24/29

### SD-38 Steam Distillation Heads, Sloping

Cat. No.	Flask Cone	Cond. cone
1264	24/29	19/26
1265	34/35	19/26

### SH-39 Splash Head, Double Bulb, Sloping

Cat. No.	Flask cone	Cond. cone	Socket
1266	24/29	19/26	14/23

### AFSH-40 Anti - Foaming Splash Head, Sloping

Cat. No.	Flask cone	Cond. cone	Socket
1267	24/29	19/26	14/23

### TP-41 Thermometer Pocket Closed end.

Cat. No.	Cone	RBF Capacity
1268	14/23	100ml
1269	19/26	100ml
1269/a	24/29	100ml
1270	14/23	250ml
1271	14/23	500ml
1272	19/26	250ml
1273	19/26	500ml
1274	24/29	250ml
1275	24/29	500ml
1276	14/23	1 ltr
1277	19/26	1 ltr
1278	24/29	1 ltr
1279	29/32	1 ltr

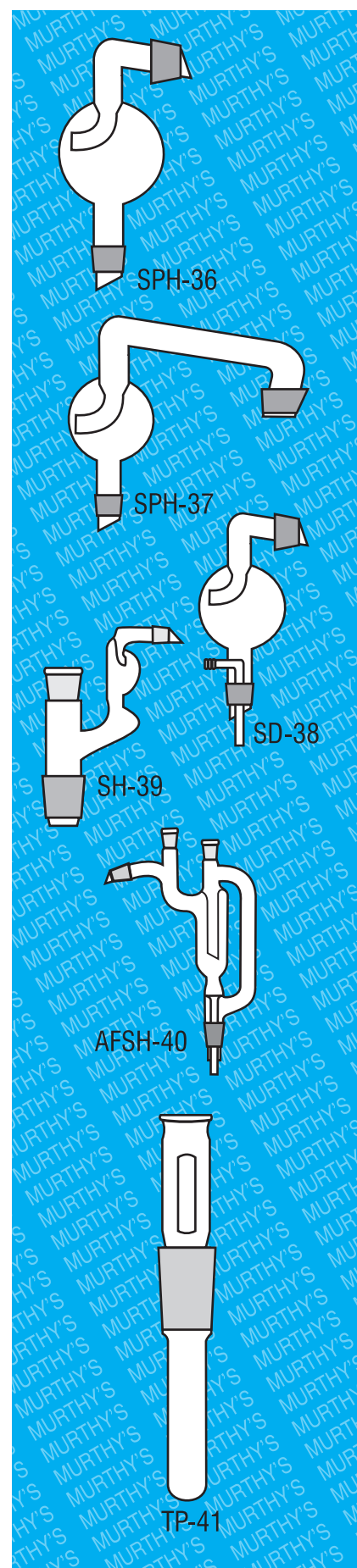

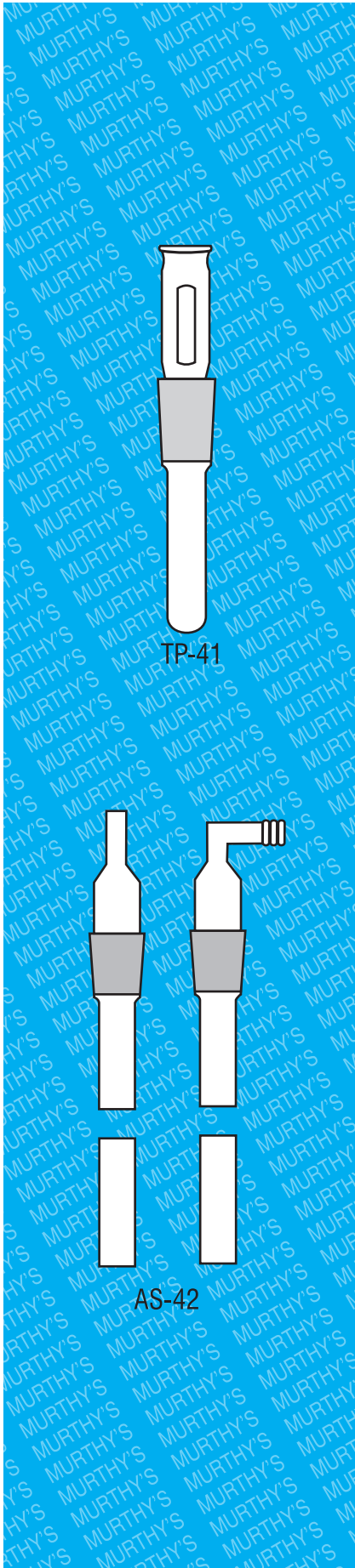

**TP-41 Thermometer Pocket Closed end.**

Cat. No.	Cone	RBF Capacity
1280	19/26	2 ltr
1281	19/26	3 ltr
1282	24/29	2 ltr
1283	24/29	3 ltr
1284	29/32	2 ltr
1285	29/32	3 ltr
1286	24/29	5 ltr
1287	29/32	5 ltr
1287/a	34/36	5 ltr
1288	24/29	10 ltr
1289	29/32	10 ltr
1290	34/35	10 ltr
1291	24/29	20 ltr
1292	29/32	20 ltr
1293	34/35	20 ltr

**AS-42 AIR/Steam Inlet Tubes, Straight**

Cat. No.	Cone	RBF Capacity
1294	14/23	250ml
1294/a	14/23	100ml
1294/b	19/26	100ml
1294/c	24/29	100ml
1295	14/23	500ml
1296	19/26	250ml
1297	19/26	500ml
1298	24/29	250ml
1299	24/29	500ml
1300	14/23	1 ltr
1301	19/26	1 ltr
1302	24/29	1 ltr
1302/a	34/35	1 ltr
1303	19/26	2 ltr
1304	24/29	2 ltr
1305	29/32	2 ltr
1306	19/26	3 ltr
1307	24/29	3 ltr
1308	29/32	3 ltr
1309	24/29	5 ltr
1310	29/32	5 ltr
1311	24/29	10 ltr
1312	29/32	10 ltr
1313	34/35	10 ltr
1314	24/29	20 ltr
1315	29/32	20 ltr
1316	34/35	20 ltr

### DT-43 Drying Tubes, Angled

Cat. No.	Cone
1317	10/19
1318	14/23
1319	19/26
1320	24/29
1321	29/32
1322	34/35

### DT-44 Drying Tubes, Straight

Cat. No.	Cone
1323	10/19
1324	14/23
1325	19/26
1326	24/29
1327	29/32
1328	34/35

### CC - 45 Calcium Chloride Tubes, straight with Line Bulb

Cat. No.	Length x Dia mm
1329	100 x 14
1330	125 x 16
1331	150 x 18

### TA-46 Tube Adapters for vacuum Release

Cat. No.	Cone
1332	19/26
1333	24/29

### TA-47 Tube Adapters for vacuum Control

Cat. No.	Cone
1334	19/26
1335	24/29

### BW-48 Bottles, Woulf, Three Necks

Cat. No.	Cap ml.	Joint
1336	500	24/29
1337	1000	24/29

### BR-48/A Bottles Reagent bottles, Narrow mouth, Stoppered

Cat. No.	Capacity	Cone
1337/a	30	14/23
1337/b	60	19/26
1337/c	125	19/26
1337/d	250	24/29
1337/e	500	24/29
1337/f	1000	24/29
1337/g	2000	34/36

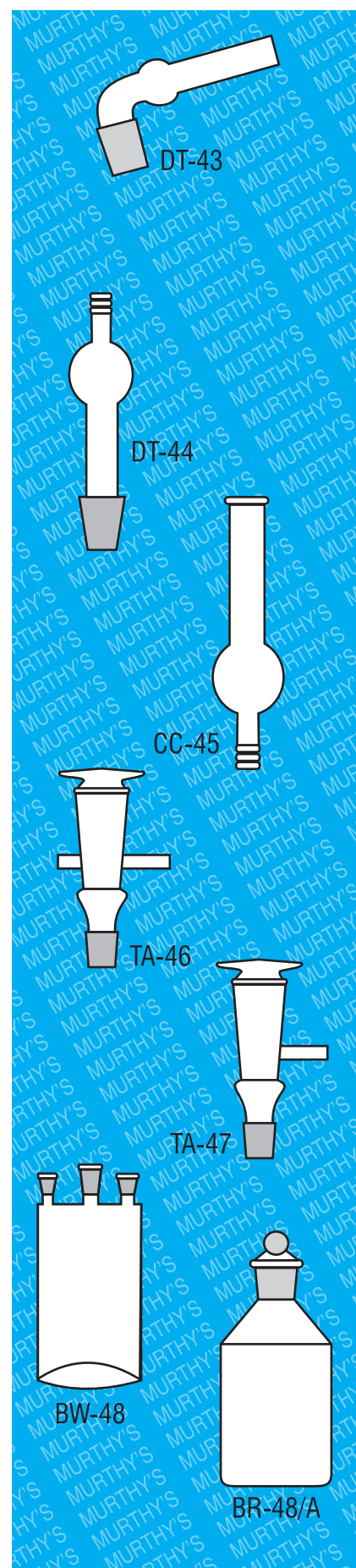



BR-48/B

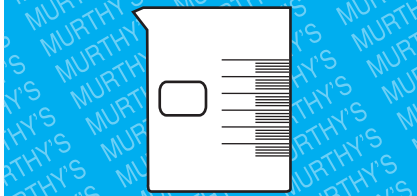

BK-047

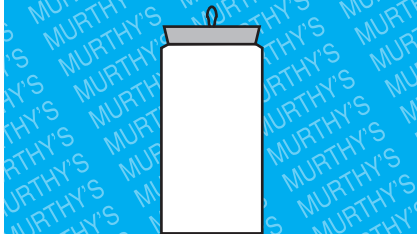

WB-49

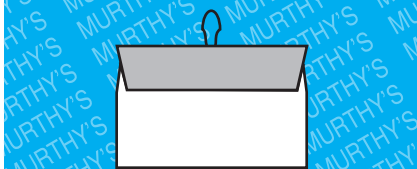

WB-50

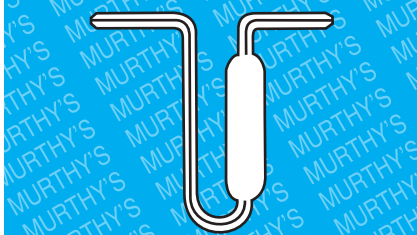

PK-51

### BR-48/B Lab Bottles Screw Type.

Cat. No.	Cap ml
332	100
333	250
334	500
335	1000
336	2000
337	5000
338	10000

### BK/047 Beakers with Spout and Graduated

Cat. No.	Cap ml.
2892	10
2893	25
2894	50
2895	100
2896	150
2897	250
2898	500
2899	1000
2900	2000

### WB-49 Weighing Bottles, Tall Form, Common Type

Cat. No.	Ht x Dia	Approx cap ml	Joint
1338	40x20	5	19/10
1339	50x35	15	24/10
1340	60x30	25	29/12
1341	80x40	60	40/13
1342	40x50	60	55/15

### WB-50 Weighing Bottles, Squat Form, Common Type

Cat. No.	Ht x Dia ml	Approx cap ml	Joint
1343	35x40	20	40/13
1344	35x50	30	50/14
1345	35x60	40	55/15

### PK-51 Pyknometers

Cat. No.	Cap ml.
1346	5
1347	10
1348	20
1349	25
1350	50

### WB-52 WashBottles, Complete

Cat. No.	Cap ml.	Joint Size
1351	250	24/29
1352	500	24/29
1353	1000	24/29

### WB-53 Wash Bottle Fitting only

Cat. No.	Cap ml.
1354	250
1355	500
1356	1000

### WB-54 Gas Washing Bottles Ordinary Complete (JOINT SIZE 29/32)

Cat. No.	Cap ml.
1357	125
1358	250
1359	500
1360	1000

### WB-55 Gas Washing Bottles, Bottle Only (JOINT SIZE 29/32)

Cat. No.	Cap ml.
1361	125
1362	250
1363	500
1364	1000

### WB-56 Gas Washing Bottles, Fitting Only (JOINT SIZE 29/32)

Cat. No.	Cap ml.
1365	125
1366	250
1367	500
1368	1000

### WB-57 Dropping Bottle Pipette Stopper

Cat. No.	Cap ml.	Joint Size
1369	30	14/15
1370	50	14/15
1371	125	19/20

### WB-58 Graduate Pipette Stopper

Cat. No.	Cap ml.	Joint Size
1372	30	14/15
1373	50	14/15
1374	125	19/20

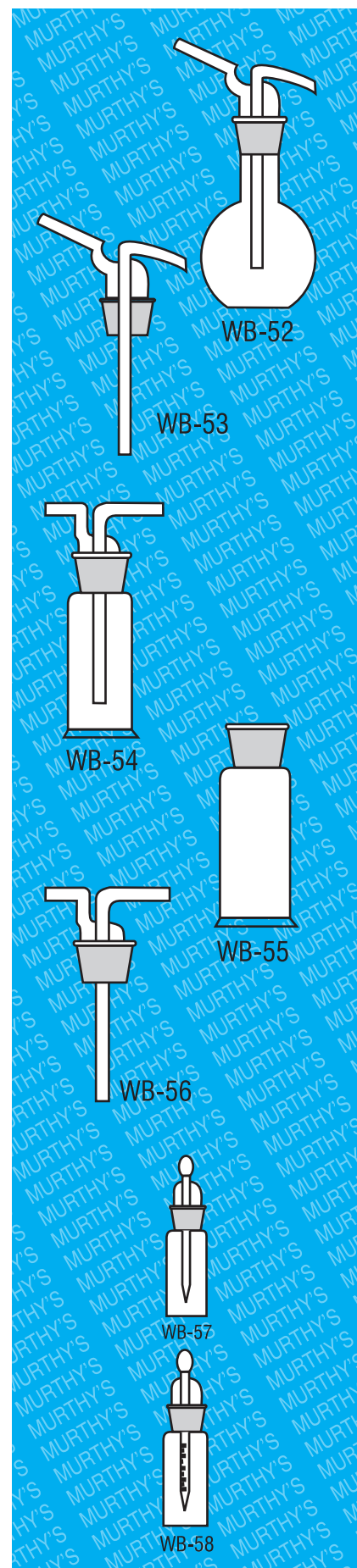

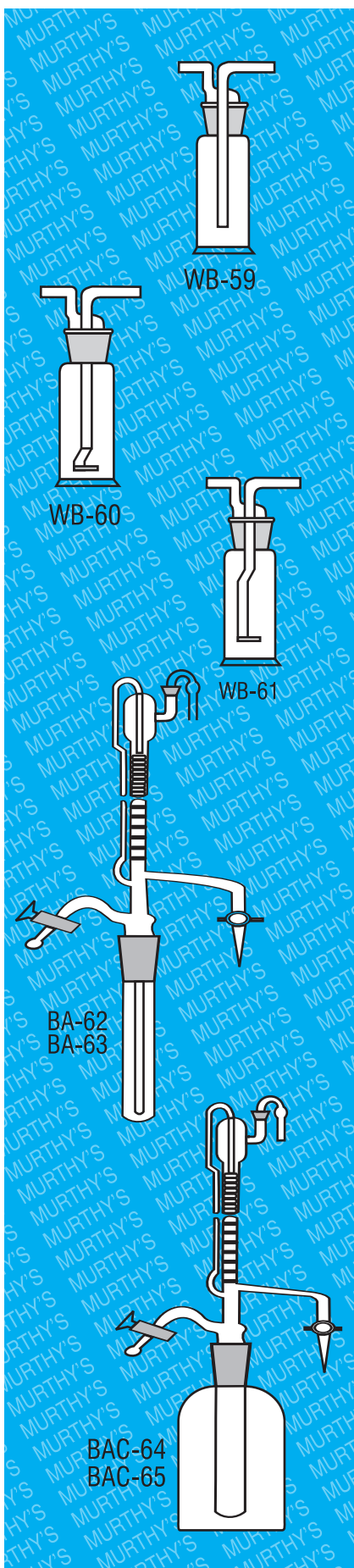

**WB-59 Gas Washing Bottles, With Sintered end For Down Ward Gas Distribution, Complete (JOINT SIZE 29/32)**

Cat. No.	Cap ml.	Disc Por
1375	125	0,1,2,3
1376	250	0,1,2,3
1377	500	0,1,2,3
1378	1000	0,1,2,3

**WB-60 Gas Washing Bottles, With Sintered end For Up Ward Distribution, Narrow Mouth, Complete, (JOINT SIZE 29/32)**

Cat. No.	Cap ml.	Disc Por
1379	125	0,1,2,3
1380	250	0,1,2,3
1381	500	0,1,2,3
1382	1000	0,1,2,3

**WB-61 Gas Washing Bottles, with sintered end for upward gas distribution, complete (Joint Size 40/38)**

Cat. No.	Cap ml.	Disc Por
1383	100	0,1,2,3
1384	250	0,1,2,3
1385	500	0,1,2,3
1386	1000	0,1,2,3

**BA-62 Burettes Automatic Class 'A'**

Cat. No.	Cap ml.
1387	10ml
1388	25ml
1389	50ml

**BA-63 Burettes Automatic Class 'B'**

Cat. No.	Cap ml.
1390	10ml
1391	25ml
1392	50ml

**BAC-64 Burettes Automatic Screw Type Class A with guard tube, bottle bellow COMPLETE SET**

Cat. No.	Cap ml.
1393	10 ml
1394	25 ml
1395	50 ml

**BAC-65 Burettes Automatic Screw Type Class B with guard tube, bottle bellow COMPLETE SET**

Cat. No.	Cap ml.
1396	10 ml
1397	25 ml
1398	50 ml



### CH-66 Condenser, Hopkin(REFLUX) Cone Size B - 19, 24, 29 Only

Cat. No.	Length mm	Body Dia mm
1399	300	30
1400	400	30

### CA-67 Condenser, Air

Cat. No.	Joint	Length mm
1401	10/19	100
1402	14/23	200
1403	19/26	200
1404	19/26	300
1405	19/26	400
1406	19/26	500
1407	19/26	600
1408	24/29	400
1409	24/29	600
1410	34/35	300 to 500

### DP 67-A Descicators Plain (Glass)

Cat. No.	Cap
DP-1	150 mm
DP-2	200 mm
DP-3	250 mm
DP-4	300 mm

### DV 67-B Descicators Vacuum (Glass)

Cat. No.	Cap
DV-6	150 mm
DV-7	200 mm
DV-8	250 mm
DV-9	300 mm

### DC 67-C Diffusion Cells

Cat. No.	Cap
DC-1	Diffusion Cells Plain, 10 ml
DC-2	Diffusion Cells Plain, 15 ml
DC-3	Diffusion Cells Plain, 20 ml
DC-4	Diffusion Cells Plain, 25 ml
DC-5	Diffusion Cells Jacketed, 10 ml
DC-6	Diffusion Cells Jacketed, 15 ml
DC-7	Diffusion Cells Jacketed, 20 ml
DC-8	Diffusion Cells Jacketed, 25 ml

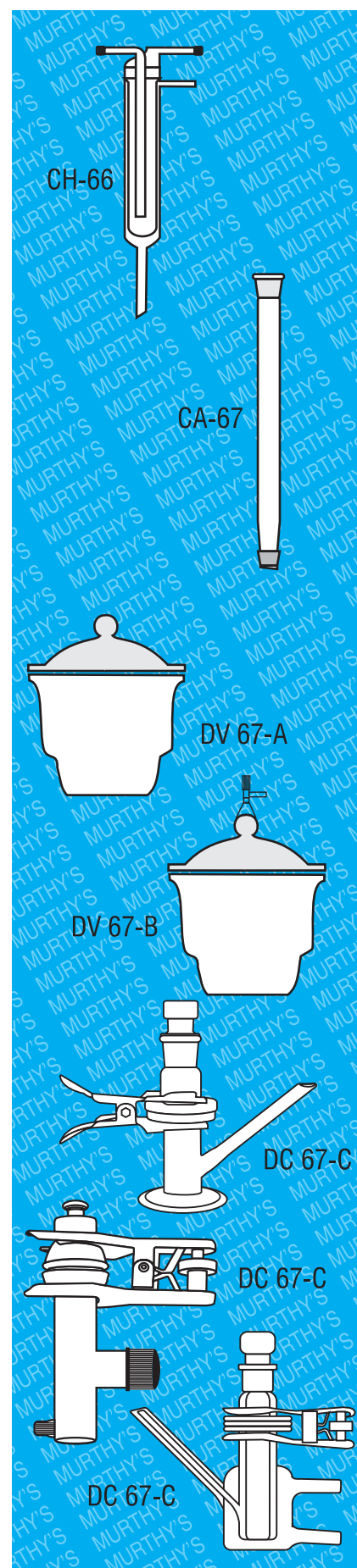

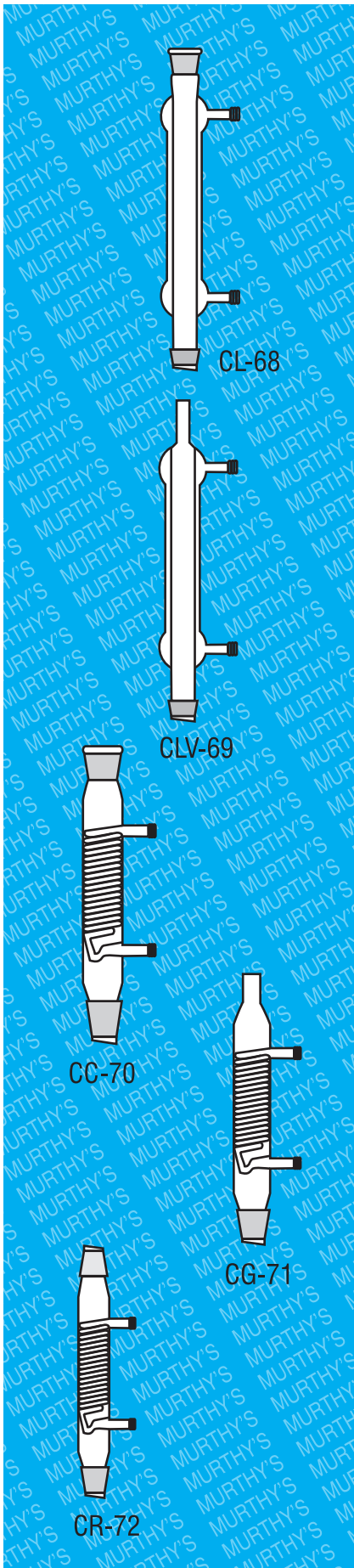

### CL-68 Condensers, Liebig

Cat. No.	Joint	Length mm
1411	10/19	60
1412	10/19	100
1413	14/23	200
1414	19/26	200
1415	19/26	300
1416	19/26	400
1417	19/26	500
1418	24/29	200
1419	24/29	300
1420	24/29	400
1421	24/29	500
1422	29/32	400
1423	29/32	500
1424	34/35	500

### CLV-69 Condensers, Liebig, Vertical

Cat. No.	Joint	Length mm
1425	19/26	300
1426	19/26	400
1427	19/26	500
1428	24/29	400
1429	24/29	500

### CC-70 Condensers, Coil (GRAHM)

Cat. No.	Joint	Length mm
1430	19/26	150
1431	19/26	300
1432	24/29	150
1433	24/29	300
1434	29/32	150
1435	29/32	300
1436	34/35	300
1437	34/35	450

### CG-71 Condensers, (GRAHM), Vertical

Cat. No.	Joint	Length mm
1438	29/32	150
1439	24/29	300
1440	34/35	300
1441	34/35	450

### CR-72 Condensers, Coil Reversible

Cat. No.	Joint	Cone	Length mm
1442	19/26	24/29	150
1443	24/29	34/35	150