

RA -08 Reaction Assembly

Cat. No. Components

2449 Round Bottom Flask 500ml, Multiple adapter two necks, Stirrer guide, Stuffing box gland with pulley, Link Stirrer 450 mm, Stillhead, Thermometer pocket, Liebig condenser 400 mm Receiver Adapter bent with vent, Round bottom flask 100 ml.

RA -09 Reaction Assembly

Cat. No. Components

2450 Round Bottom Flask 1000 ml, Multiple adapter two necks, Stirrer guide, Rubber sleeve gland, collapsible Paddle Stirrer 450 mm stillhead jacketed coil condenser 150 mm, Receiver adapter bent with socket connection Round bottom flask 250ml, Double surface condenser 200 mm, Cone adapter bent.

RA -10 Reaction Assembly

Cat. No. Components

2451 R. B flask, 500 ml. Multiple adapter two necks, Claisen head, Liebig condenser 200mm, Receiver adapter bent with vent, R. B Flasks, 250 ml, Separating funnel 100ml Separating funnel 100 ml, stopper, thermometer Pocket.

RA -11 Reaction Assembly

Cat. No. Components

2452 R.B Flasks, 500 ml, Liebig condenser, 400mm, Adapter with T. connection, Separating funnel 100 ml, Stopper.

RA -12 Reaction Assembly

Cat. No. Components

2453 R.B. Flask, 250 ml, Multiple adapter, two necks, stillhead Liebig condenser, 200 mm, receiver adapter, Thermometer pocket, separating funnel, 100 ml stopper.

RA -13 Reaction Assembly

Cat. No. Components

2454 R.B Flask, 1000ml, Multiple adapter three necks, Stirrer guide, stuffing box gland with pulley, Collapsible paddle stirrer, 450 mm, still head, Liebig condenser, 400 mm Receiver adapter, Bent with socket connection R.B. flasks, 500 ml, drying tube, Thermometer pocket separating funnel, 100ml, Stopper.

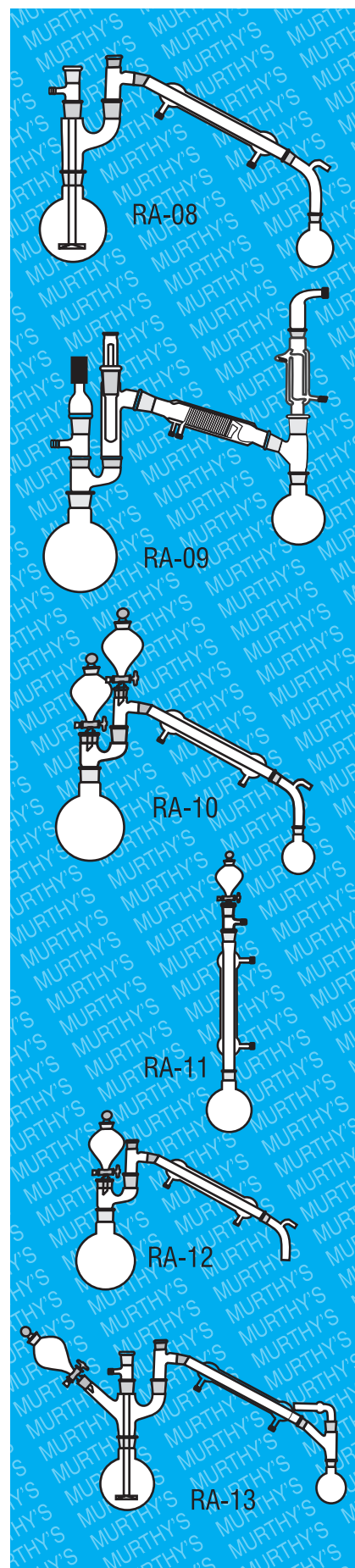

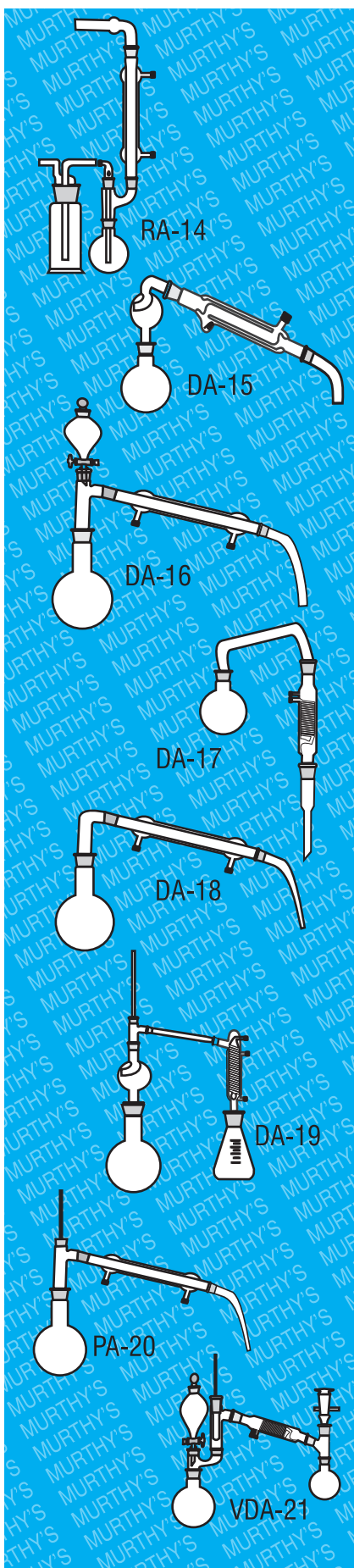

RA -14 Reaction Assembly

Cat. No. Components

- 2455 R.B flask, 250 ml, Multiple adapter, two neck
Air leak tube, bent, Liebig condenser, 200 mm,
Drying tube, Gaswash bottle body, 250 ml, Gas
Wash bottle fitting.

DA -15 Distillation Assembly

Cat. No. Components

- 2456 R.B. Flask, 2000 ml, splash head, Doublesurface
Condenser, 200 mm, Receiver adapter

DA -16 Distillation Assembly

Cat. No. Components

- 2457 R.B.flask, 500 ml, Stillhead Liebig condenser
400 mm, Receiver adapter, separating funnel,
100 ml, Stopper

DA -17 Distillation Assembly

Cat. No. Components

- 2458 R.B.flask, 1000ml, Recovery bend, Thorpe
Condenser, 200 mm Receiver adapter

DA -18 Distillation Assembly

Cat. No. Components

- 2459 R.B.flask, 250 ml Recovery bend,
Liebig condenser 200 mm Receiver Adapter

DA -19 Distillation Assembly

Cat. No. Components

- 2460 R.B flask, 3000 ml, splash head adapter, still
head Air condenser, 400 mm, Ether Condenser,
Receiver adapter, Conicalflask, 1000 ml, Stopper

PA -20 Preparation Assembly

Cat. No. Components

- 2461 R.B. Flask, 500 ml, Still head, Thermometer
With PTFE cone Liebig condenser, 200 mm
Receiver adapter

VDA - 21 vacuum Distillation Assembly

Cat. No. Components

- 2462 R.B. flask, 3000 ml, multiple adapter, two neck
Stillhead jacked coil condenser 150 mm, Receiver
Adapter, bent with socket connection R.B.flask,
250ml vacume release stopcock, separating
funnel 250ml, stopper

VDA - 22 vacuum Distillation Assembly

Cat. No. Components

- 2463 R.B.flask, 100 ml, Multiple adapter, two necks, Stillhead Air condenser, 400 mm, Receiver Adapter, bent with vent, R.B. flask, 50 ml, Separating funnel 50 ml, stopper

VDA-23 vacuum Distillation Assembly

Cat. No. Components

- 2464 R.B. flask, 500ml, splash head, Double bulb, Double surface condenser, 200mm Receiver Adapter, with Vacuum connection, Round Bottom flask 100 ml Air leak tube

VDA - 24 vacuum Distillation Assembly

Cat. No. Components

- 2465 R.B.flask, 500ml, Jacketed coil condenser 150 mm Receiver adapter, with Vacuum connection R.B Flask, 100 ml, Test tube, 200ml, Gas wash bottle Fitting, Air leak tube

VDA-25 vacuum Distillation Assembly

Cat. No. Components

- 2466 R.B.flask, 1000ml, Recovery bend, Double Coil condenser Round bottom flask, two necks 500ml, Vacuum release stopcock

VDA-26 vacuum Distillation Assembly

Cat. No. Components

- 2467 R.B. flask, 1000 ml, Recovery bend, Jacketed Coil condenser 150 mm, Receiver adapter, bend with vent, R.B.flask, 250ml

KDA - 27 Kjeldal Distillation Assembly

Cat. No. Components

- 2468 R.B. flask, 1000ml, Multiple adapter, two Necks, splash head, vertical, Liebig condenser, 400mm, Receiver adapter, separating funnel 100 ml

KDA - 28 Kjeldal Distillation Assembly

Cat. No. Components

- 2469 Kjeldahi flask, 800ml, Multiple adapter, two necks, splash head, vertical, Liebig condenser, 400mm receiver adapter, separating funnel 100 ml

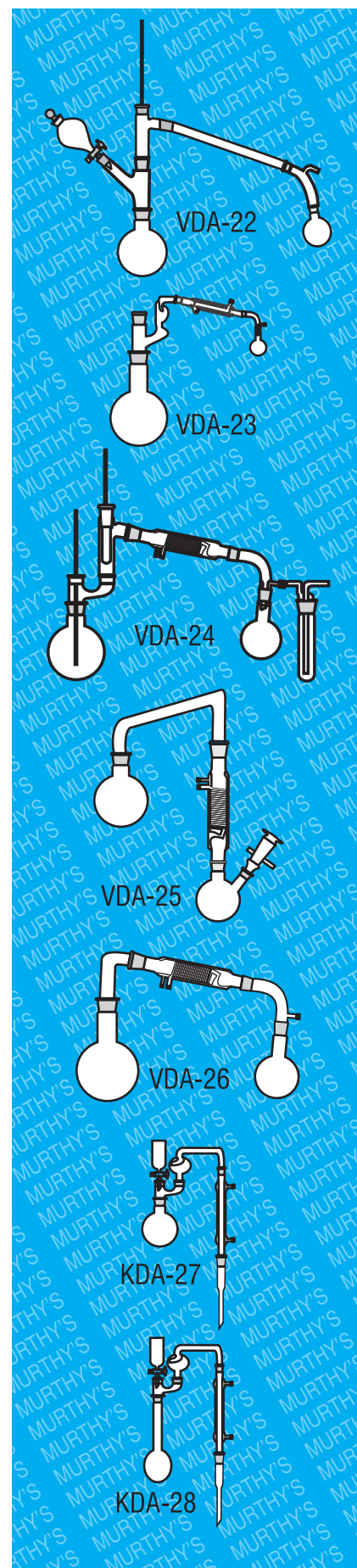

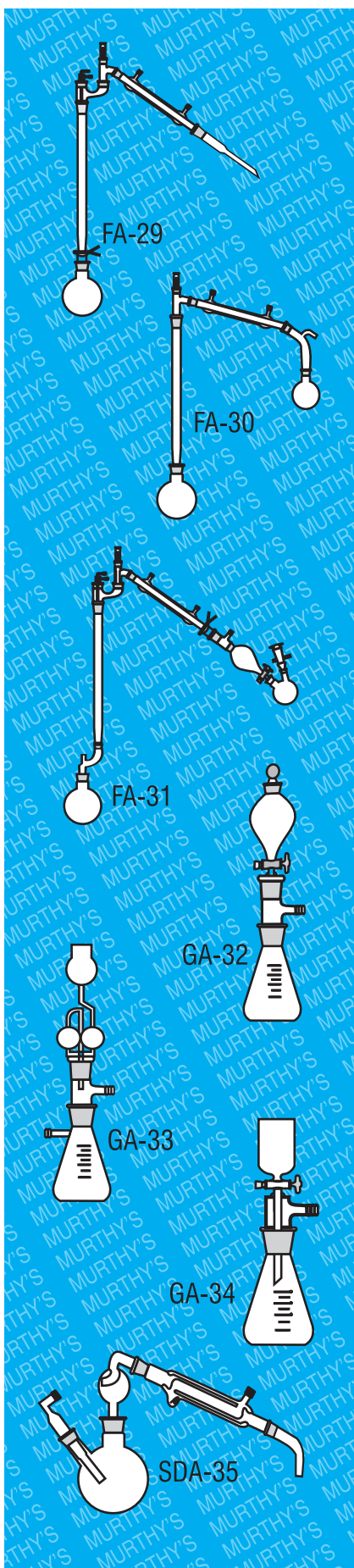

FA - 29 Fractionation Assembly

Cat. No. Components

- 2470 R.B. flask, 500ml, Cup Joint adapter, ball joint adapter Joint clip, S35 Air Condenser, 300 mm, Multiple adapter, two necks, Immersion condenser Stillhead, Thermometer pocket Receiver adapter, plain bend Liebig condenser, 400mm, Receiver adapter

FA - 30 Fractionation Assembly

Cat. No. Components

- 2471 R.B. flask, 250ml, Air condenser, 400 mm, Stillhead Liebig condenser, 200 mm bend with multiple connection 3 x R.B. flask, 25 ml

FA - 31 Fractionation Assembly

Cat. No. Components

- 2472 R.B. flask, 100 ml, swan neck adapter, air Condenser 400 mm, multiple adapter, Two necks Immersion condenser, stillhead liebig condenser 400 mm, all joint adapter cup joint adapter, adapter with 'T' Connection, separating funnel, 100 ml, Reduction adapter R.B. flask two necks, 500 ml, vacuum release stopcock, joint clip, S 29

GA - 32 Gas Evolution Assembly

Cat. No. Components

- 2472 Conical flask, 1000 ml, Adapter with 'T' Connection separating funnel, 500ml, Stopper

GA - 33 Gas Evolution Assembly

Cat. No. Components

- 2473 Buchner flask, 100 ml, thistle funnel head

GA - 34 Gas Evolution Assembly

Cat. No. Components

- 2474 Conical flask, 500 ml, separating funnel, 100 ml,

SDA - 35 Steam Distillation Assembly

Cat. No. Components

- 2475 R.B. flask, two necks 500 ml, splash head Liebig condenser 200 mm, receiver adapter, Air leak Tube

SDA - 36 Steam Distillation Assembly

Cat. No. Components

2476 R.B. flask, 500 ml, air leak tube, Liebig condenser 400 mm, receiver adapter,

SDA - 37 Steam Distillation Assembly

Cat. No. Components

2477 R.B. flask, 500 ml, steam distillation head Liebig condenser 400 mm, receiver adapter,

SDA - 38 Steam Distillation Assembly

Cat. No. Components

2478 R.B. flask, 100 ml, anti foaming splash Head Air leak tube thermometer pocket Receiver Adapter, Coil condenser 300 mm, Adapter With 'T' Connection R.B. flask 250 ml.

SDA- 39 Steam Distillation Assembly

Cat. No. Components

2479 R.B. flask, 500 ml, Multiple adapter, Two necks, air leak tube ben, recovery Bend, jacketed coil condenser, 150 mm, Receiver adapter.

FLDA - 40 Frothy liquids Distillation Assembly

Cat. No. Components

2480 RB Flast 100 ml, anti foaming splash Head Air leak tube thermometer pocket Receiver Adapter, Coil condenser 300mm, Adapter With 'T' Connection R.B. flask 250 ml.

DDA- 41 Destructive Distillation Assembly

Cat. No. Components

2481 R.B. flask, 1000 ml, sill head thermometer with PTFE cone liebig condenser 400 mm, gas absorption Adapter with vacuum Break

GAA - 42 Gas absorption Assembly

Cat. No. Components

2482 2 x U- tubes with socket 1 x U- tube with cone, drying tube, cone adapter bent

VSA - 43 Vacuum Sublimation Assembly

Cat. No. Components

2483 Test tube, adapter with T' Connection,

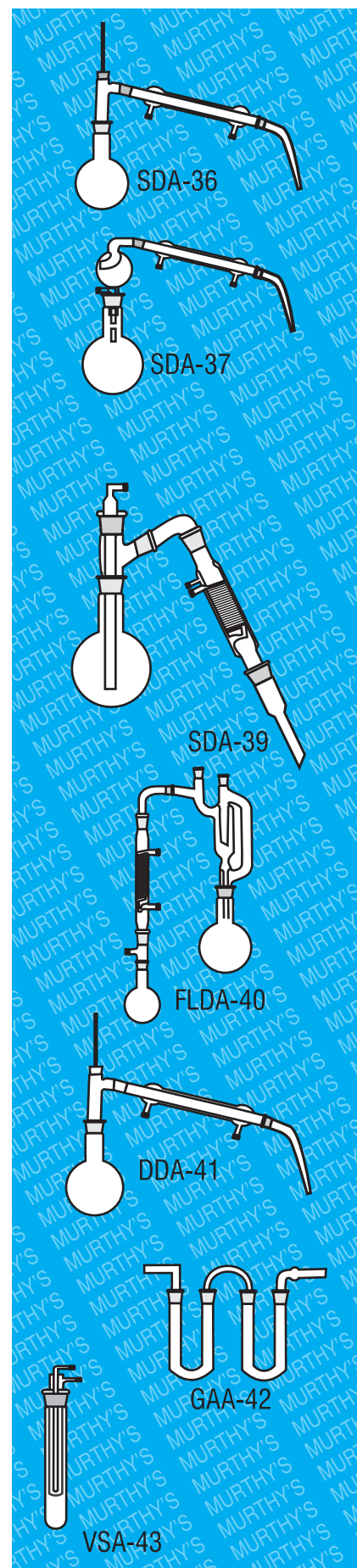

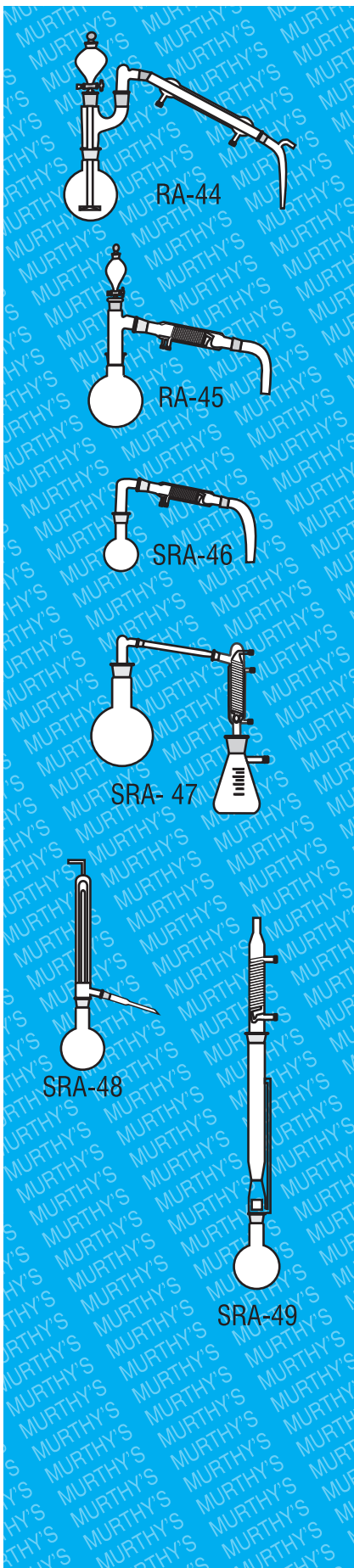

RA - 44 Recovery Assembly

Cat. No. Components

2484 R.B. flask, 250 ml, Multiple adapter,
Two necks Recovery Bend, Liebig
Condenser 400 mm, Receiver adapter,
separating funnel, 100 ml,

RA - 45 Recovery Assembly

Cat. No. Components

2485 R.B. flask, 2000 ml, Stillhead jacketed
Coil Condenser, 150 mm Receiver adapter,
separating funnel, 100 ml, Stopper

SRA - 46 Solvent Recovery Assembly

Cat. No. Components

2486 F.B. flask, 150 ml, Recovery Bend, Jacketed
coil condenser 150 mm, Receiver adapter

SRA - 47 Solvent Recovery Assembly

Cat. No. Components

2487 R.B. flask, 250 ml, Recovery Bend, Liebig
Condenser 400 mm, Receiver adapter,
Bent with vent R.B. flask, 250 ml

SRA - 48 Solvent Recovery Assembly

Cat. No. Components

2488 R.B. flask, 500 ml, Recovery Bend,
Air Condenser 200 mm, Either condenser
Buchner Flask 250 ml

SRA- 49 Solvent Recovery Assembly

Cat. No. Components

2489 R.B. flask, 500 ml, Hopin
Condenser, Receiver adapter

SRA - 50 Solvent Recovery Assembly

Cat. No. Components

2490 F.B. flask, 250 ml, Plain
Body extractor, Coil Condenser 150 mm

MS - 51 Miniature Set (basic)

This miniature set is ideal for organic chemistry preparations upto 15 gram scale One joint size (10/19) is used throughout. Some of the model assemblies are shown below.

Cat. No. Components

- | | |
|------|---------------------------------|
| 2491 | 1. Pear shaped flask 25 ml |
| | 2. Stillhead |
| | 3. Liebig condenser 60mm |
| | 4. Receiver adapter |
| | 5. Cylindrical funnel 20 ml |
| | 6. stopper |
| | 7. Thermometer with PTFE cone |
| | 8. Air leak tube with PTFE cone |

MS - 52 Miniature Set (Comprehensive)

This miniature set contains all the parts of basic set, plus the additional parts as illustrated. Thus more Assemblies could be assembled as shown below:

Cat. No. Components

- | | |
|------|-------------------------------------|
| 2492 | 1 to 8 of 2491 |
| | 9. pear shape flask 3 necks, 25 ml |
| | 10. R.B. flask 5 ml |
| | 11. Receiver adapter bent with vent |
| | 12. Air condenser 100 mm |
| | 13. Liebig condenser 60 mm |
| | 14. filter tube |
| | 15. stopper |

SMS - 53 Semi Micro St (Basic)

This Semi set is ideal for organic chemistry preparation up to 30 gram scale. One joint size (14/23) is used throughout. Some of the model assemblies are shown below:

Cat. No. Components

- | | |
|------|---------------------------------|
| 2493 | 1. Pear shaped flask 50 ml |
| | 2. Stillhead |
| | 3. Liebig condenser 150 ml |
| | 4. Receiver adapter |
| | 6. Stopper |
| | 7. Thermometer with PTFE cone |
| | 8. Air leak tube with PTFE cone |

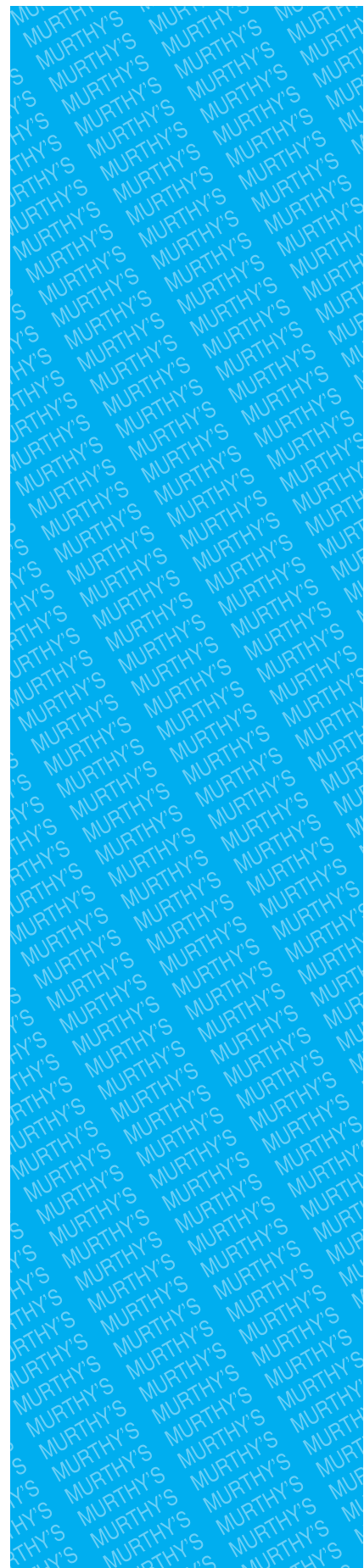

SMS - 54 Semi Micro set (Comprehensive)

This Semi Micro set contains all the parts of basic set plus the additional parts as illustrated. Thus more assemblies could be assembled, as shown below. Condenser is duplicated because of its more usage.

Cat. No. Components

- | | |
|------|---|
| 2494 | 1 to 8 of (2493) |
| | 9. 2 necks pear shaped flask 50 ml |
| | 10. R.B. flask 25 ml |
| | 11. Receiver adapter with vacuum connection |
| | 12. Air condenser 200 mm |
| | 13. Liebig condenser 150 mm |
| | 14. Adapter with T connection |
| | 15. Drying tube Components Price |

MS - 55 Micro Set (basic)

This Micro set is ideal for organic Chemistry preparations up to 150gram Scale. One joint size (19/26) is used through out some of the model assemblies or shown below.

Cat. No. Components

- | | |
|------|------------------------------------|
| 2495 | 1. R.B. flask 250ml |
| | 2. Still head |
| | 3. Liebig condenser 200mm |
| | 4. Receiver adapter |
| | 5. Cylindrical funnel 100ml |
| | 6. stopper |
| | 7. Thermometer with P.T.F.E cone |
| | 8. Air leak tube with P.T.F.E cone |
| | 9. Pear shaped flask 100ml |
| | 10. Buchner flask 100ml |

MS- 56 Micro set (Comprehensive)

This Micro set contains all the parts of Basic set plus the additional parts as illustrated. Thus more assemblies could be assembled, as shown below. Condenser is duplicated because of its more usage

Cat. No. Components

- | | |
|------|---|
| 2496 | 1 to 10 of 2495 |
| | 11. 3 necks R.B. flask 250ml |
| | 12. Receiver adapter with vacuum connection |
| | 13. Air Condenser 150mm |
| | 14. Liebig condenser 200mm |
| | 15 Drying tube |
| | 16. P T F E Balded stirrer with PTFE cone |
| | 17. Sintered conical filter |

LES - 57 Laboratory Equipment Set

This set is ideal for use in preparative organic chemistry upto 150 gram scale both for students as well as industrial laboratories with items 1 to 16 included in this set illustrations 1-7 shown below could be assembled.

Cat. No. Components

- | | |
|------|-----------------------------|
| 2497 | 1. Stillhead |
| | 2. Receiver adapter |
| | 3. Air leak tube |
| | 4. Liebig condenser 200 mm |
| | 5. 100 ml separating funnel |
| | 6. Reduction adapter |
| | 7. Multiple adapter |
| | 8. 50 ml R.B. flask |
| | 9. 250 ml conical flask |
| | 10. 250 ml R.B. flask |
| | 11. Stopper |
| | 12. Stopper |
| | 13. Thermometer Pocket |
| | 14. Receiver adapter, bent |
| | 15. 100 ml R.B. flask |
| | 16. Stopper |

LES - 58 Laboratory Equipment Set

This set permits working upto 300 gms scale with provision for stirring and more refined equipment for steam distillation. With items 1-26 included in this set and illustrations 1-14 shown could be assembled.

Cat. No. Components

- | | |
|------|---------------------------------|
| 2498 | 1 to 16 of 2497 |
| | 17. Stirrer, link |
| | 18. Stirrer guide |
| | 19. Spalsh head |
| | 20. 500 ml pear shaped funnel |
| | 21. Adapter with 'T' connection |
| | 22. Drying tube |
| | 23. Drying tube |
| | 24. 500 ml R.B. flask |
| | 25. Stirrer gland |
| | 26. Air leak tube 150 mm |

LES - 59 Laboratory Equipment set

This set is Suitable for work upto 1 Kg Scale with more refined Stirring apparatus larger capacity flask, fractionating column etc., and is Excellent for research work. With items 1-46 included in this set illustration 1-20 shown could be assembled.

Cat. No. Components

2499	1 to 26 of 2498
	27. stirrer, collapsible paddle
	28. Air condenser
	29 Double Surface condenser
	30 Air leak tube
	31 Ground Sleeve stirred gland
	32 Reduction adapter
	33 Vigreux column
	34 Thermometer 0° to 25° C, PTFE cone
	35 Thermometer pocket
	36 adapter, bent
	37 Stopper
	38 Stopper
	39 Test tube
	40 Test tube
	41 1000ml, R.B. three necks flask
	42 250ml R B two necks flask
	43 2000ml R B
	44 stirrer pulley
	45 250ml conical flask
	46 1000ml R B flask